



MOP-GL12232D

Parallel Display Specifications

Revision 1.0

Revision History

Revision	Date	Description	Author
1.0	March 25, 2012	Initial Release	Clark

Contents

- Revision History 1
- Contents 2
- Features 3
- Hardware 3
 - Drawing 3
 - Interface 3
- Instructions 4
 - Outline 4
 - Instruction Table 4
 - Timing Characteristics 5
- Specifications 6
 - Electrical 6
 - Optical 6
 - Environmental 6
- Troubleshooting 7
 - Power 7
 - Display 7
 - Communication 7
 - Precautions 7
- Ordering 8
 - Part Numbering Scheme 8
 - Options 8
- Contact 8

Features

The Matrix Orbital Parallel display series offers a low cost display solution utilizing an industry standard communication interface for simple integration into a wide variety of new and existing applications. The Light Emitting Diode backlight with configurable brightness and voltage controlled contrast allows the MOP Liquid Crystal Display line to offer a professional display solution for any project.

Hardware

Drawing

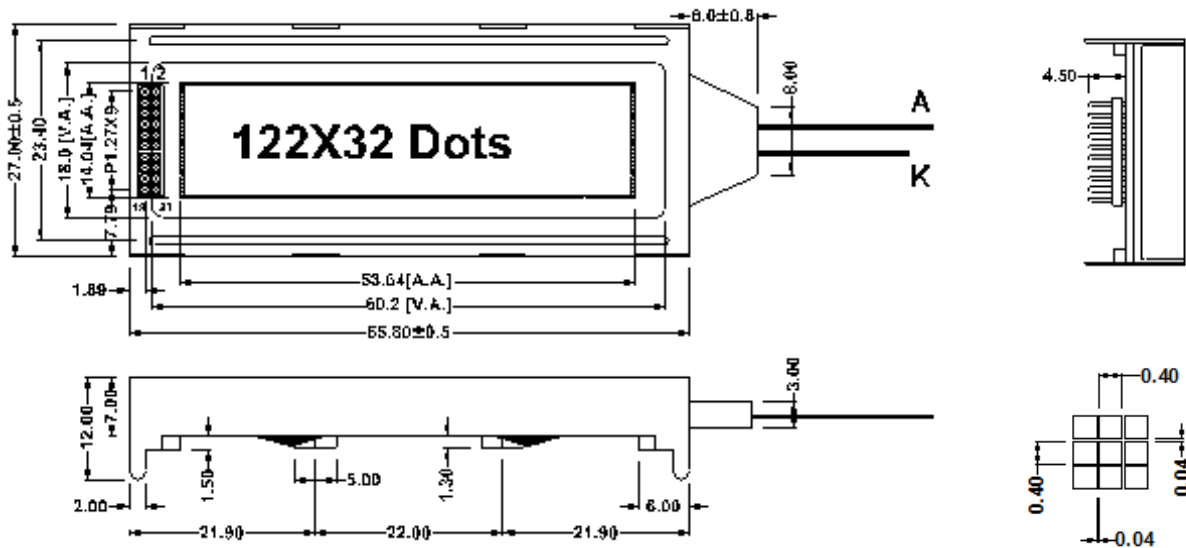

Figure 1: MOP-GL12232D Mechanical Drawing

Interface

Table 1: Display Control

Pin	Symbol	Description
1	RS	Register Select
2	CS2	Chip Enable (Right)
3	CS1	Chip Enable (Left)
4	NC	No Connect
5	NC	No Connect
6	W/R	Write/Read
7	V _{SS}	Ground
16	V _{DD}	Supply Voltage for Logic
17	RST	Reset
18	V ₀	Supply Voltage for LCD (Contrast)
19	NC	No Connect
20	NC	No Connect

Table 2: Parallel Data and Backlight

Pin	Symbol	Description
8	DB0	Data bit 0
9	DB1	Data bit 1
10	DB2	Data bit 2
11	DB3	Data bit 3
12	DB4	Data bit 4
13	DB5	Data bit 5
14	DB6	Data bit 6
15	DB7	Data bit 7
A	LED (+)	Backlight Anode
K	LED (-)	Backlight Cathode

*Note: Offered on applicable units only

Instructions

Outline

The MOP-GL12232D is controlled using a standard SED1520 compliant controller. The display is enabled by pulling the Enable (E) pin high, communication to and from the device is controlled by pulling the Read/Write (R/W) line high or low respectively, and the unit may be reset at power up by pulling the reset (RST) line low. Using Register Select (RS), either the data register or command register is selected by toggling RS high or low respectively.

Before any data is read or written, the status of the display controller should be read. This is accomplished by setting RS low, R/W high, E high, and reading the status byte that appears on the data lines. Each bit of the status word indicates a specific condition, outlined below.

Table 3: Status Bits

Bit	Description	Status
D0	Unused.	Unused.
D1	Unused.	Unused.
D2	Unused.	Unused.
D3	Unused.	Unused.
D4	Reset.	0:Normal, 1:Reset.
D5	Display On/Off.	0:Display On, 1:Display Off.
D6	Display Data Direction.	0: Counter-CW, 1: Clockwise.
D7	Busy status.	0:Ready, 1:Busy.

Instruction Table

Table 4: Parallel Instruction Table

Instruction	Control		Instruction Code							
	RS	R/W	DB7	DB6	DB5	DB4	DB3	DB2	DB1	DB0
Display On	0	0	1	0	1	0	1	1	1	1
Display Off	0	0	1	0	1	0	1	1	1	0
Display Start Line	0	0	1	1	0	Start Line				
Set (X) Page	0	0	1	0	1	1	1	0	X Page	
Set (Y) Address	0	0	0	Y Address						
Status Read	0	1	Busy	ADC	On/Off	Reset	0	0	0	0
Write Display Data	1	0	Write Data							
Read Display Data	1	1	Read Data							
Counter-CW Display Data	0	0	1	0	1	0	0	0	0	1
Clockwise Display Data	0	0	1	0	1	0	0	0	0	0
Static Drive On	0	0	1	0	1	0	0	1	0	1
Dynamic Drive On	0	0	1	0	1	0	0	1	0	0
Set Data Auto Write	0	0	1	1	1	0	0	0	0	0
End Data Auto Write	0	0	1	1	1	0	1	1	1	0
Reset	0	0	1	1	1	0	0	0	1	0

Timing Characteristics

Table 5: Read and Write Operation Specifications

Item	Symbol	Min	Typ	Max	Unit
Address Hold Time	t_{AH}	10	—	—	ns
Address Set-Up Time	t_{AW}	20	—	—	ns
System Cycle Time	t_{CYC}	1000	—	—	ns
Control Pulse Width	t_{CC}	200	—	—	ns
Data Set-Up Time	t_{DS}	80	—	—	ns
Data Hold Time	t_{DH}	10	—	—	ns
Access Time	t_{ACC}	—	—	90	ns
Output Hold Time	t_{OH}	10	—	60	ns

Conditions: $T_a = -20^{\circ}\text{C}$ to 75°C , $V_{DD} = 5.0 \pm 0.5\text{V}$

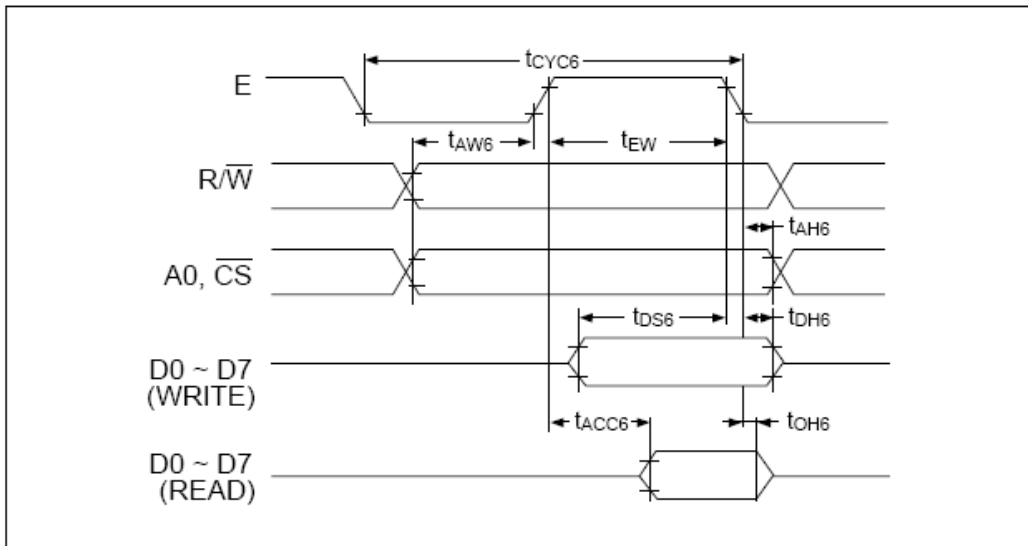

Figure 2: Read/Write Timing Waveform

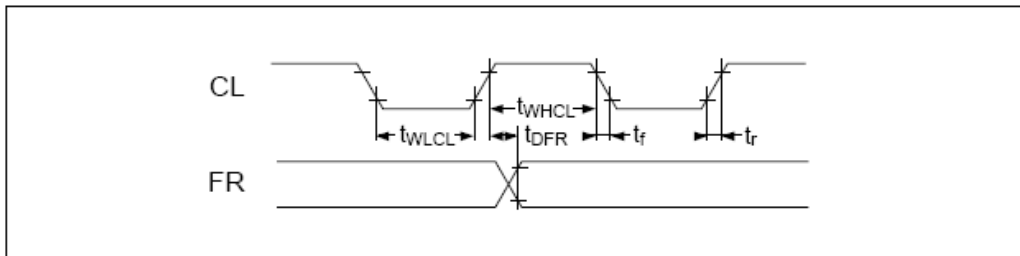

Figure 3: Control Timing Waveform

Specifications

Electrical

Table 6: Electrical Characteristics

Item	Symbol	Min	Typ	Max	Unit
Supply Voltage For Logic	V_{DD}	4.5	5.0	5.5	V
Supply Voltage For LCD (Contrast)	V_0	-0.5	0.2	0.9	V
Input High Voltage	V_{IH}	$0.8 V_{DD}$	—	V_{DD}	V
Input Low Voltage	V_{IL}	V_{SS}	—	$0.2 V_{DD}$	V
Supply Current ($V_{DD}=5V$)	I_{DD}	—	0.5	1.5	mA
Supply Voltage of White Backlight (2 Die)	V_{LED}	2.9	3.1	3.3	V
Supply Current of White Backlight (2 Die)	I_{LED}	0	—	50	mA

Optical

Table 7: Display Characteristics

Item	Dimension	Unit
Number of Pixels	122 Columns x 32 Rows	—
Module dimension	65.8 x 27.0 x 12.0	mm
View area	60.2 x 18.0	mm
Active area	53.64 x 14.04	mm
Dot size	0.40 x 0.40	mm
Dot pitch	0.44 x 0.44	mm
Duty	1/32	
View direction	12 o'clock	

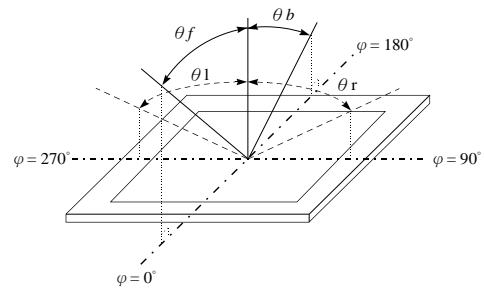

Figure 4: Viewing Angle Definition

Table 8: Viewing Characteristics

Item	Symbol	Min	Typ	Max	Unit
View Angle	(V) θ	-40	—	20	deg
	(H) ϕ	-50	—	50	deg
Contrast Ratio	CR	3	6	—	—
Response Time	T rise	—	150	200	ms
	T fall	—	150	200	ms

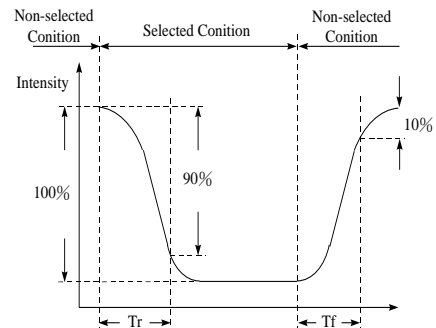

Figure 5: Display Response Time

Environmental

Table 9: Environmental Specifications

Item	Symbol	Min	Max	Unit
Operating Temp.	Top	-20	70	°C
Storage Temp.	Tstr	-30	80	°C

Note: Maximum 90% non-condensing humidity.

Troubleshooting

Power

For your MOP Display to function correctly, appropriate power must be applied, often as indicated by the backlight illuminating or a darkening of the character spaces. Please refer to the power diagram below and reference all voltages to the specifications provided.

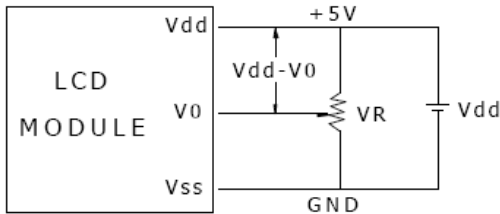

Vdd-V0: LCD Driving Voltage
VR: 10K - 20K

Figure 6: Display with Negative Voltage Output

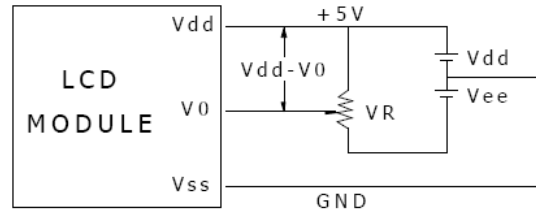

Vdd-V0: LCD Driving Voltage
VR: 10K - 20K

Figure 7: Display without Negative Voltage Output

Display

If your display is powered successfully, the backlight or contrast should be evident. A lack of text could be the result of a high contrast voltage, lower V_0 .

Communication

When communication of either text or commands is interrupted, check all data and control pins for continuity. Finally, slow down communication and refer to timing diagrams and specifications for proper control flow.

Precautions

- Do not make extra holes in the display, modify its shape, or change the components.
- Avoid applying excessive electrical or mechanical shock to the module.
- Do not drop, bend, twist, or disassemble the display.
- Avoid operation outside absolute maximum ratings.
- Solder only to the I/O terminals provide, ensuring proper grounding.
- Store in an anti-static container within a clean environment, clean carefully if necessary.

Ordering

Part Numbering Scheme

Table 10: Parallel Part Numbering Scheme

MOP	G	L	122	32	D	B	G	F	W	2	6	N	3	I	N
1	2	3	4	5	6	7	8	9	10	11	12	13	14	15	16

Options

Table 11: Parallel Part Options

#	Designator	Options
1	Product Line	MOP: Matrix Orbital Parallel Display
2	Display Type	G: Graphic
3	Screen Type	L: Liquid Crystal Display
4	Display Columns	122: One Hundred Twenty-Two Pixel Columns 240: Two Hundred Forty Pixel Columns
5	Display Rows	32: Thirty-Two Pixel Rows 64: Sixty-Four Pixel Rows 128: One Hundred Twenty-Eight Pixel Rows
6	Display Form Factor	A: A Form Factor B: B Form Factor D: D Form Factor F: F Form Factor
7	IC Package	B: Chip on Board
8	LCD Glass Type	B: STN Positive Blue G: STN Positive Grey S: Special W: FSTN Positive Y: STN Positive Yellow
9	Polarizer Style	F: Transflective S: Special T: Transmissive
10	Backlight Colour	X: Inverse Tricolour Y: Yellow-Green W: White
11	Viewing Angle	1: 6:00 2: 12:00
12	Controller	2: T6963 Compatible 6: SED 1520 Compatible
13	Character Set	N: None
14	Input Voltage	3: 5.0V
15	Temperature Range	I: Industrial S: Standard
16	Negative Voltage Generation	N: None Provided Y: Negative Voltage Output Provided

Contact

Sales

Phone: 403.229.2737

Email: sales@matrixorbital.ca

Support

Phone: 403.204.3750

Email: support@matrixorbital.ca

Online

Purchasing: www.matrixorbital.com

Support: www.matrixorbital.ca