



# MOP-GL12232B

---

## Parallel Display Specifications

Revision 1.0

## Revision History

Revision	Date	Description	Author
1.0	March 25, 2012	Initial Release	Clark

# Contents

- Revision History ..... 1
- Contents ..... 2
- Features ..... 3
- Hardware ..... 3
  - Drawing ..... 3
  - Interface ..... 3
- Instructions ..... 4
  - Outline ..... 4
  - Instruction Table ..... 4
  - Timing Characteristics ..... 5
- Specifications ..... 6
  - Electrical ..... 6
  - Optical ..... 6
  - Environmental ..... 6
- Troubleshooting ..... 7
  - Power ..... 7
  - Display ..... 7
  - Communication ..... 7
  - Precautions ..... 7
- Ordering ..... 8
  - Part Numbering Scheme ..... 8
  - Options ..... 8
- Contact ..... 8

## Features

The Matrix Orbital Parallel display series offers a low cost display solution utilizing an industry standard communication interface for simple integration into a wide variety of new and existing applications. The Light Emitting Diode backlight with configurable brightness and voltage controlled contrast allows the MOP Liquid Crystal Display line to offer a professional display solution for any project.

## Hardware

### Drawing

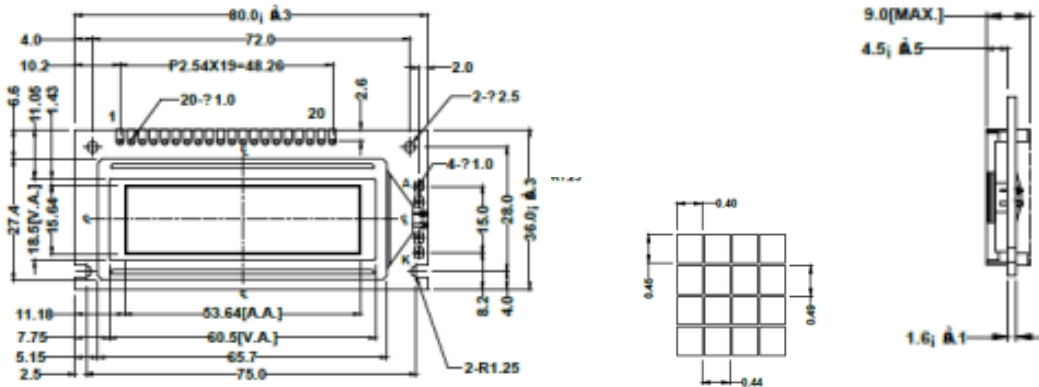

Figure 1: MOP-GL12864F Mechanical Drawing

## Interface

Table 1: Display Control

Pin	Symbol	Description
1	V <sub>SS</sub>	Ground
2	V <sub>DD</sub>	Supply Voltage for Logic
3	V <sub>0</sub>	Supply Voltage for LCD (Contrast)
4	RS	Register Select
5	CS1	Chip Enable (Left)
6	CS2	Chip Enable (Right)
7	CL	Clock
8	E	Enable
9	R/W	Read/ Write
18	RST	Reset

Table 2: Parallel Data and Backlight

Pin	Symbol	Description
10	DB0	Data bit 0
11	DB1	Data bit 1
12	DB2	Data bit 2
13	DB3	Data bit 3
14	DB4	Data bit 4
15	DB5	Data bit 5
16	DB6	Data bit 6
17	DB7	Data bit 7
19	LED (+)	Backlight Anode
20	LED (-)	Backlight Cathode

## Instructions

### Outline

The MOP-GL12232B is controlled using a standard SED1520 compliant controller. The display is enabled by pulling the Enable (E) pin high, communication to and from the device is controlled by pulling the Read/Write (R/W) line high or low respectively, and the unit may be reset at power up by pulling the reset (RST) line low. Using Register Select (RS), either the data register or command register is selected by toggling RS high or low respectively.

Before any data is read or written, the status of the display controller should be read. This is accomplished by setting RS low, R/W high, E high, and reading the status byte that appears on the data lines. Each bit of the status word indicates a specific condition, outlined below.

Table 3: Status Bits

Bit	Description	Status
D0	Unused.	Unused.
D1	Unused.	Unused.
D2	Unused.	Unused.
D3	Unused.	Unused.
D4	Reset.	0:Normal, 1:Reset.
D5	Display On/Off.	0:Display On, 1:Display Off.
D6	Display Data Direction.	0: Counter-CW, 1: Clockwise.
D7	Busy status.	0:Ready, 1:Busy.

### Instruction Table

Table 4: Parallel Instruction Table

Instruction	Control		Instruction Code							
	RS	R/W	DB7	DB6	DB5	DB4	DB3	DB2	DB1	DB0
Display On	0	0	1	0	1	0	1	1	1	1
Display Off	0	0	1	0	1	0	1	1	1	0
Display Start Line	0	0	1	1	0	Start Line				
Set (X) Page	0	0	1	0	1	1	1	0	X Page	
Set (Y) Address	0	0	0	Y Address						
Status Read	0	1	Busy	ADC	On/Off	Reset	0	0	0	0
Write Display Data	1	0	Write Data							
Read Display Data	1	1	Read Data							
Counter-CW Display Data	0	0	1	0	1	0	0	0	0	1
Clockwise Display Data	0	0	1	0	1	0	0	0	0	0
Static Drive On	0	0	1	0	1	0	0	1	0	1
Dynamic Drive On	0	0	1	0	1	0	0	1	0	0
Set Data Auto Write	0	0	1	1	1	0	0	0	0	0
End Data Auto Write	0	0	1	1	1	0	1	1	1	0
Reset	0	0	1	1	1	0	0	0	1	0

## Timing Characteristics

Table 5: Read and Write Operation Specifications

Item	Symbol	Min	Typ	Max	Unit
Address Hold Time	$t_{AH}$	10	—	—	ns
Address Set-Up Time	$t_{AW}$	20	—	—	ns
System Cycle Time	$t_{CYC}$	1000	—	—	ns
Control Pulse Width	$t_{CC}$	200	—	—	ns
Data Set-Up Time	$t_{DS}$	80	—	—	ns
Data Hold Time	$t_{DH}$	10	—	—	ns
Access Time	$t_{ACC}$	—	—	90	ns
Output Hold Time	$t_{OH}$	10	—	60	ns
Read Pulse Width	$t_{EW}$	100	—	—	ns
Write Pulse Width	$t_{EW}$	80	—	—	ns

Conditions:  $T_a = -20^{\circ}\text{C}$  to  $75^{\circ}\text{C}$ ,  $V_{DD} = 5.0 \pm 0.5\text{V}$

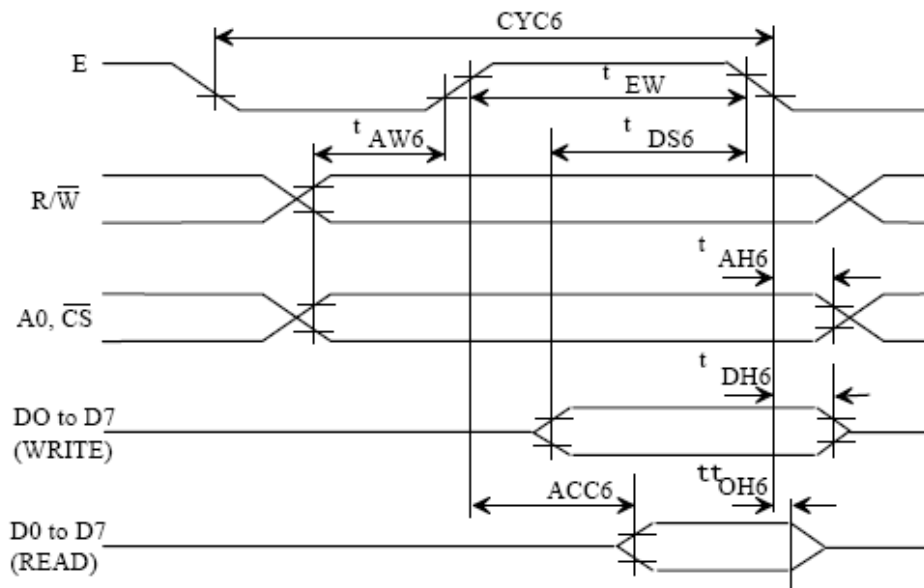

Figure 2: Read/Write Timing Waveform

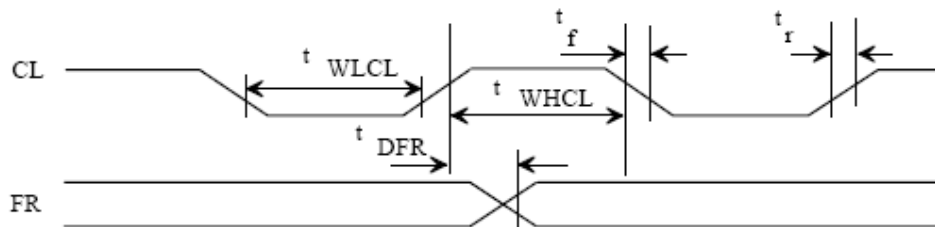

Figure 3: Control Timing Waveform

# Specifications

## Electrical

Table 6: Electrical Characteristics

Item	Symbol	Min	Typ	Max	Unit
Supply Voltage For Logic	$V_{DD}$	4.5	5.0	5.5	V
Supply Voltage For LCD (Contrast)	$V_0$	-2.0	-1.5	-1.0	V
Input High Voltage	$V_{IH}$	$0.7 V_{DD}$	—	$V_{DD}$	V
Input Low Voltage	$V_{IL}$	$V_{SS}$	—	$0.3 V_{DD}$	V
Supply Current ( $V_{DD}=5V$ )	$I_{DD}$	—	1.0	3.0	mA
Supply Voltage of White Backlight (1 Die)	$V_{LED}$	2.9	3.1	3.3	V
Supply Current of White Backlight (1 Die)	$I_{LED}$	0	—	20	mA

## Optical

Table 7: Display Characteristics

Item	Dimension	Unit
Number of Pixels	122 Columns x 32 Rows	—
Module dimension	80.0 x 36.0 x 9.0	mm
View area	60.5 x 18.5	mm
Active area	53.64 x 15.64	mm
Dot size	0.45 x 0.45	mm
Dot pitch	0.49 x 0.49	mm
Duty	1/32	
View direction	6 o'clock	

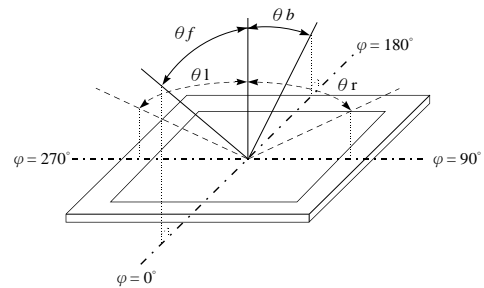

Figure 4: Viewing Angle Definition

Table 8: Viewing Characteristics

Item	Symbol	Min	Typ	Max	Unit
View Angle	(V) $\theta$	-20	—	35	deg
	(H) $\phi$	-30	—	30	deg
Contrast Ratio	CR	—	3	—	—
Response Time	T rise	—	—	250	ms
	T fall	—	—	250	ms

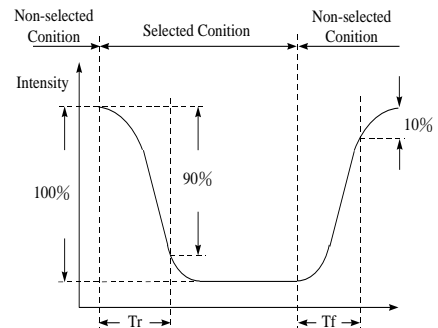

Figure 5: Display Response Time

## Environmental

Table 9: Environmental Specifications

Item	Symbol	Min	Max	Unit
Operating Temp.	Top	0	50	°C
Storage Temp.	Tstr	-10	60	°C

**Note:** Maximum 90% non-condensing humidity.

# Troubleshooting

## Power

For your MOP Display to function correctly, appropriate power must be applied, often as indicated by the backlight illuminating or a darkening of the character spaces. Please refer to the power diagram below and reference all voltages to the specifications provided.

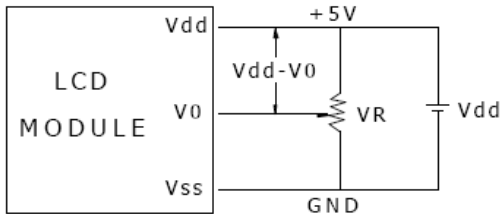

Vdd-V0: LCD Driving Voltage  
VR: 10K - 20K

6: Display with Negative Voltage Output

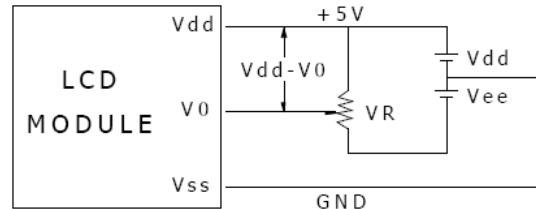

Vdd-V0: LCD Driving Voltage  
VR: 10K - 20K

7: Display without Negative Voltage Output

Figure

## Display

If your display is powered successfully, the backlight or contrast should be evident. A lack of text could be the result of a high contrast voltage, lower  $V_0$ .

## Communication

When communication of either text or commands is interrupted, check all data and control pins for continuity. Finally, slow down communication and refer to timing diagrams and specifications for proper control flow.

## Precautions

- Do not make extra holes in the display, modify its shape, or change the components.
- Avoid applying excessive electrical or mechanical shock to the module.
- Do not drop, bend, twist, or disassemble the display.
- Avoid operation outside absolute maximum ratings.
- Solder only to the I/O terminals provide, ensuring proper grounding.
- Store in an anti-static container within a clean environment, clean carefully if necessary.



## Ordering

### Part Numbering Scheme

Table 10: Parallel Part Numbering Scheme

<b>MOP</b>	<b>G</b>	<b>L</b>	<b>122</b>	<b>32</b>	<b>B</b>	<b>B</b>	<b>G</b>	<b>F</b>	<b>W</b>	<b>1</b>	<b>6</b>	<b>N</b>	<b>3</b>	<b>S</b>	<b>N</b>
1	2	3	4	5	6	7	8	9	10	11	12	13	14	15	16

### Options

Table 11: Parallel Part Options

#	Designator	Options
1	Product Line	MOP: Matrix Orbital Parallel Display
2	Display Type	G: Graphic
3	Screen Type	L: Liquid Crystal Display
4	Display Columns	128: One Hundred Twenty-Two Pixel Columns 240: Two Hundred Forty Pixel Columns
5	Display Rows	32: Thirty-Two Pixel Rows 64: Sixty-Four Pixel Rows 128: One Hundred Twenty-Eight Pixel Rows
6	Display Form Factor	A: A Form Factor B: B Form Factor D: D Form Factor F: F Form Factor
7	IC Package	B: Chip on Board
8	LCD Glass Type	B: STN Positive Blue G: STN Positive Grey S: Special W: FSTN Positive Y: STN Positive Yellow
9	Polarizer Style	F: Transflective S: Special T: Transmissive
10	Backlight Colour	X: Inverse Tricolour Y: Yellow-Green W: White
11	Viewing Angle	1: 6:00 2: 12:00
12	Controller	2: T6963 Compatible 6: SED 1520 Compatible
13	Character Set	N: None
14	Input Voltage	3: 5.0V
15	Temperature Range	I: Industrial S: Standard
16	Negative Voltage Generation	N: None Provided Y: Negative Voltage Output Provided

## Contact

### Sales

Phone: 403.229.2737

Email: [sales@matrixorbital.ca](mailto:sales@matrixorbital.ca)

### Support

Phone: 403.204.3750

Email: [support@matrixorbital.ca](mailto:support@matrixorbital.ca)

### Online

Purchasing: [www.matrixorbital.com](http://www.matrixorbital.com)

Support: [www.matrixorbital.ca](http://www.matrixorbital.ca)